

**ABLOY® DOOR CLOSERS**  
*Exactly the right choice*



## ABLOY® DOOR CLOSERS – SUPERIOR PERFORMANCE AND RELIABILITY

**ABLOY®** high security products are known and highly-respected all over the world.

Every item in our wide product range represents top quality and superior performance.

**ABLOY®** door closers protect door constructions by controlling the opening and closing actions of the door. Reliable performance over a wide operational temperature range guarantees that energy will be saved and security increased.

Production of **ABLOY®** door closers started in the 1930s. Today, we employ the very latest technology in our new purpose-built production facilities. Our long experience and extensive expertise combined with customer-oriented research and development mean that we have a wide range of solutions for the varying demands of different door environments.

Our global network of sales offices and distributors will help you to choose the right product to increase security and convenience in your specific application. The functions, features, and wide variety of installation alternatives offered by **ABLOY®** door closers give you convenient operation, simplified installation and ease of adjustment and maintenance.

### CLOSING TIME AS A FUNCTION OF TEMPERATURE

Changes in temperature have only a minimal affect on the performance of **ABLOY®** door closers.

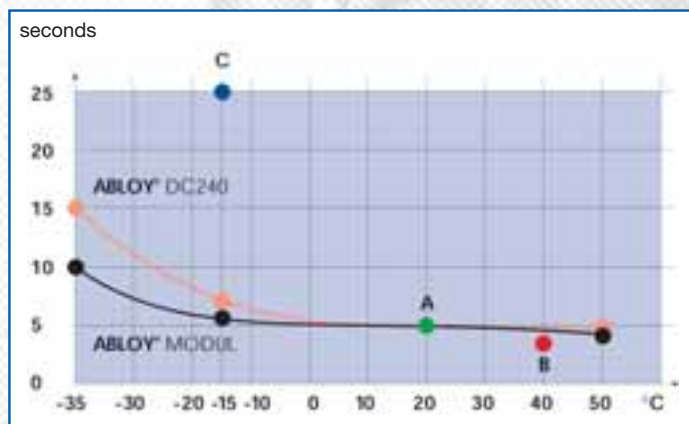

The EN1154 standard specifies the following:

- A A standard closing time of 5 seconds at +20 °C
- B A minimum closing time of 3 seconds at +40 °C (check point only)
- C A maximum closing time of 25 seconds at -15 °C (check point only)



## ABLOY® DC210

### Applications:

Interior doors with a maximum weight of 60 kg and a maximum door leaf width of 950 mm.

### Features:

- Adjustable class 2 or 3 closing force according to EN1154
- Maximum opening angle 180 °
- Adjustable closing and latching speed
- Installation on door frame or door leaf
- Die-cast aluminium body
- Width 210 mm, height 42 mm, depth 56 mm
- Arm included in the package



## ABLOY® MODUL DC233

### Applications:

Interior doors with a maximum weight of 60 kg and a maximum door leaf width of 950 mm.

### Features:

- Class 3 closing force according to EN1154
- Separate adjustment of closing and latching speed
- Starting angle of latching can be adjusted
- Installation on door frame or door leaf
- Available with standard arm and sliding arm (see page 30)
- Easy adjustment of arm height (maximum 14 mm)
- Aluminium profile body
- Removable plastic cover, for colours see page 30
- A pressure relief valve to protect against abuse
- Wide operating range: +45 °C to -35 °C
- Width 273 mm, height 63 mm, depth 46,5 mm



## ABLOY® MODUL DC234

### Applications:

Interior and exterior doors with a maximum weight of 80 kg and a maximum door leaf width of 1100 mm.

### Features:

- Class 4 closing force according to EN1154
- Separate adjustment of closing and latching speed
- Starting angle for latching can be adjusted
- Installation on door frame or door leaf
- Available with standard arm and sliding arm (see page 30)
- Easy adjustment of arm height (maximum 14 mm)
- Aluminium profile body
- Removable plastic cover, for colours see page 30
- Back check (BC) available as an accessory
- Adjustable BC starting angle
- A pressure relief valve to protect against abuse
- Wide operating range: +45 °C to -35 °C
- Width 273 mm, height 63 mm, depth 46,5 mm



## ABLOY® MODUL DC235

### Applications:

Interior and exterior doors with a maximum weight of 100 kg and a maximum door leaf width of 1250 mm.

### Features:

- Adjustable class 3 - 5 closing force according to EN1154
- Separate adjustment of closing and latching speed
- Starting angle for latching can be adjusted
- Installation on door frame or door leaf
- Available with standard arm and sliding arm (see page 30)
- Easy adjustment of arm height (maximum 14 mm)
- Aluminium profile body
- Removable plastic cover, for colours see page 30
- Back check (BC) available as an accessory
- Adjustable BC starting angle
- Delayed closing (DC) available as an accessory
- A pressure relief valve to protect against abuse
- Wide operating range: +45 °C to -35 °C
- Width 273 mm, height 63 mm, depth 46,5 mm



## ABLOY® DC240

### Applications:

Suitable for exterior doors, large doors and interior doors exposed to conditions of pressure and heavy use. Maximum door weight 120 kg, maximum door leaf width 1400 mm. When installed with a sliding arm, the maximum door weight is 80 kg and the maximum door leaf width is 1100 mm.

### Features:

- Adjustable class 2 - 6 closing force according to EN1154 and class 2 – 6 in ANSI 156.4
- Separate adjustment of closing and latching speed
- Starting angle for latching can be adjusted
- Back check (BC) as standard feature
- Delayed closing (DC) as an accessory
- Adjustable BC starting angle
- Two pressure relief valves to protect against abuse
- Available with standard arm and sliding arm (see page 30)
- Can be installed to door or door frame
- Easy adjustment of arm height (maximum 14 mm)
- Cast aluminium body
- Available with removable plastic, steel or stainless steel cover. For colours see page 30.
- Wide operating range: +50 °C to -35 °C
- Width 306 mm, height 69 mm, depth 63 mm



## ABLOY® DC241

### Applications:

Suitable for interior doors of average size and weight. Recommended maximum door weight 100 kg, recommended maximum door leaf width 1250 mm.

### Features:

- Adjustable class 1 - 5 closing force according to EN1154, and class 1 – 5 in ANSI 156.4
- Separate adjustment of closing and latching speed
- Starting angle for latching can be adjusted
- A pressure relief valve to protect against abuse
- Available with standard arm and sliding arm (see page 30)
- Can be installed to door or door frame
- Easy adjustment of arm height (maximum 14 mm)
- Cast aluminium body
- Available with removable plastic, steel or stainless steel cover. For colours see page 30.
- Wide operating range: +50 °C to -35 °C
- Width 306 mm, height 69 mm, depth 63 mm



## ABLOY® DC247

### Applications:

Suitable for use on internal and external doors. Ideal for ships and other extremely heavy door applications.

### Features:

- Adjustable class 6 - 7 closing force
- Separate adjustment of closing and latching speed
- Easy adjustment of arm height ( maximum 14 mm)
- Starting angle of latching can be adjusted
- Back check as standard feature
- Can be installed to door or door frame
- For use with arm DC197
- Cast aluminium body
- Removable plastic cover, for colours see page 30
- Wide operating range: +50 °C to -35 °C
- Width 306 mm, height 69 mm, depth 63 mm

## ABLOY® DC250

### Applications:

Suitable for use in all interior and exterior doors. For use with FD450 series fire door closing systems. Maximum door weight is 100 kg and maximum door leaf width is 1250 mm.

### Features:

- Adjustable Class 1 - 5 closing force according to EN1154
- Separate adjustment of closing and latching speed
- Easy adjustment of arm height (maximum 14 mm)
- Back check (BC) as a standard feature
- Two pressure relief valves to protect against abuse
- Non-handed
- Can be installed to door or door frame
- Available with removable plastic, steel or stainless steel cover. For colours see page 30.
- For use with sliding arm DC193 or DC194
- Cast aluminium body manufactured from high-performance silicon alloy
- Wide operating range: +45 °C to -15 °C
- Width 306 mm, height 69 mm, depth 63 mm

## ABLOY® DC270

### Applications:

**ABLOY® DC270** is designed especially for ships and extremely heavy doors with sliding arms DC193 and DC194. It is double installation model where DC250 and DC247 are installed to the same mounting plate and under only one cover. It has enough power to close the door in all circumstances whole closing range when the door is tilted even 3,5 degrees.

### Features:

- Adjustable class 6 - 7 closing force according to EN1154
- Fulfill shipbuilders requirements when door is tilted even 3,5 degrees and door size is 1290 mm width and weight 110 kg
- Separate adjustment of closing and latching using only adjusting valves of DC247
- Starting angle of latching can be adjusted
- Back check as a standard feature
- Full metal cover, for colours see page 30
- Easy adjustment of arm height (maximum 14 mm)
- Can be installed to door or door frame
- Width 332 mm, height 136, depth 65mm





## ABLOY® DC752 and ABLOY® DC755 FLOOR SPRINGS

### Applications:

Heavy duty floor springs with adjustable power for doors up to 300 kg and from 850 to 1400 mm wide.

### Features:

- Adjustable class 3 - 6 closing force according to EN1154
- Suitable for right, left or double action doors by just changing the accessories
- Separate adjustment of closing and latching speed
- Max door opening angle up to 180°
- DC755 has hold open function in 90°
- DC752 is without hold open function
- Against corrosion steel sheet is hot zinc plated, body is painted of acrylpolyurethan paint and adjusting-fixing screws are Dacromet treated
- Width 345 mm, height 78 mm, depth 82 mm

## ABLOY® DC701

ABLOY® DC701 is an accessory hinge packet to the floor springs. It is straight model and suitable to the double action door.

## ABLOY® DC702

ABLOY® DC702 is an accessory hinge packet to the floor springs. It is 36 mm offset model to the right or left hand single acting door.

## ABLOY® DC802 CONCEALED DOOR CLOSER

### Applications:

Concealed door closer to aluminium profiles up to 850 mm wide. Concealed either in the door or head frame. When installed into the door max opening angle is 140° and when installed into the head frame max opening angle is 160°.

### Features:

- Class 2 closing force according to EN1154
- Separate adjustment of closing and latching speed
- Hold open device as an optional
- Height 221 mm, width 35,5 mm, depth 78,5 mm

## ABLOY® DC804 CONCEALED DOOR CLOSER

### Applications:

Concealed door closer to aluminium profiles up to 1100 mm wide. Concealed either in the door or head frame. When installed into the door max opening angle is 140° and when installed into the head frame max opening angle is 160°.

### Features:

- Class 4 closing force according to EN1154
- Separate adjustment of closing and latching speed
- Hold open device as an optional
- Height 327 mm, width 35,5 mm, depth 78,5 mm

## ABLOY® DC812 CONCEALED DOOR CLOSER

### Applications:

Concealed door closer to timber doors up to 850 mm wide. Concealed either in the door or head frame. When installed into the door max opening angle is 140° and when installed into the head frame max opening angle is 160°.

### Features:

- Class 2 closing force according to EN1154
- Separate adjustment of closing and latching speed
- Hold open device as an optional
- Height 221 mm, width 35,5 mm, depth 78,5 mm

## ABLOY® DC814 CONCEALED DOOR CLOSER

### Applications:

Concealed door closer to timber doors up to 1100 mm wide. Concealed either in the door or head frame. When installed into the door max opening angle is 140° and when installed into the head frame max opening angle is 160°.

### Features:

- Class 4 closing force according to EN1154
- Separate adjustment of closing and latching speed
- Hold open device as an optional
- Height 327 mm, width 35,5 mm and depth 78,5 mm

## ABLOY® DC852 HOLD OPEN DEVICE

DC852 is hold open device to the concealed door closers. Hold open angle is adjustable.

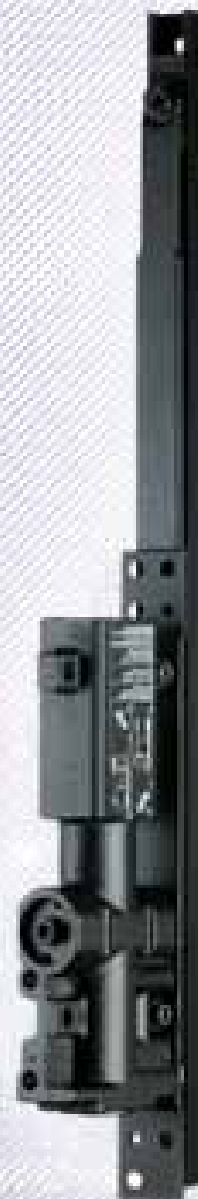



**ABLOY® FD440 ELECTROHYDRAULIC HOLD OPEN DEVICE**



**Applications:**

Suitable for large doors and interior doors exposed to conditions of pressure and heavy use. Especially for fire doors. Maximum door weight 120 kg and maximum door leaf width 1400 mm. When installed with a sliding arm the maximum door weight is 80 kg and maximum door leaf width 1100 mm.

**Features:**

- Electrohydraulic hold open device for single doors
- Based on DC240 door closer.
- Available with standard and sliding free swing arms

**ABLOY® FD450 ELECTROMECHANICAL HOLD OPEN DEVICE**



**Applications:**

Single doors of maximum door leaf width 1250 mm

**Features:**

- Electromechanical hold-open device for single doors
- To be used with one DC250 door closer

**ABLOY® FD451 MECHANICAL DOOR COORDINATOR**



**Applications:**

Double doors with maximum door opening of 1250 - 2500 mm.

**Features:**

- Can be used with wall magnets
- To be used with 2 pcs DC250 door closers

**Accessories:**

Support brackets available to simplify installation.





**ABLOY® FD452**  
ELECTROMECHANICAL HOLD OPEN DEVICE

**Applications:**

Double doors with maximum door opening of 1250 – 2500 mm.

**Features:**

- Two electromechanical hold open devices
- Supplied with coordinator and arms
- To be used with 2 pcs DC250 door closers

**ABLOY® FD454**  
ELECTROMECHANICAL HOLD OPEN DEVICE

**Applications:**

Double doors with maximum door opening of 1250 – 2500 mm.

**Features:**

- Electromechanical hold open device for active door or hold open for both doors with hold open device in inactive door and coordinator in active door
- Supplied with coordinator and arms
- To be used with 2 pcs DC250 door closers



**ABLOY®** FD440 Electrohydraulic hold open device

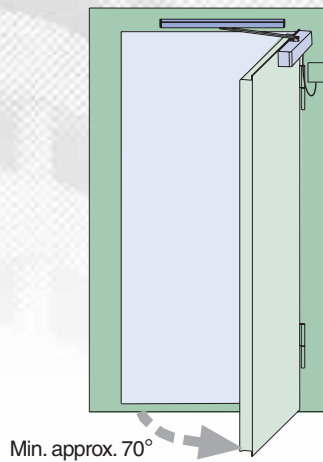

Closing forces according to EN1154:	
With arms 7199 and FD499	EN 2-6
With arms DC194 and FD494	EN 1-4

With free swing arms the first opening is like with a normal door closer. The door is opened to the desired angle to determine the opening angle for later use (min. approx. 70°). The opening angle can also be increased later simply by pushing the door further. After the first opening the free swing function enables the door to be opened and closed freely, without any resistance. When the power is switched off, i.e. when the smoke detectors react to smoke, the door closes always regardless of the door position. Current consumption 90 mA (24VDC).

**ABLOY®** FD450 Hold open for active door

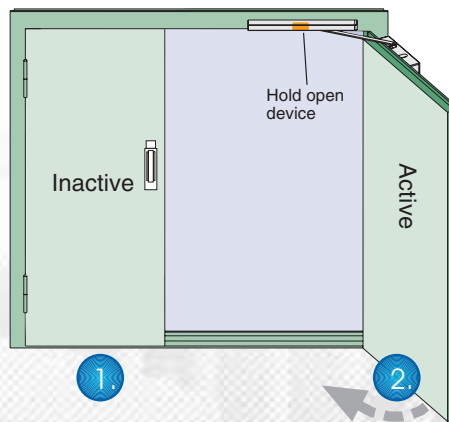

The inactive door is normally closed (1) and remains open only if someone holds it open. When the power is switched off, e.g. when smoke detectors react to smoke, the active door closes. Hold open angle for active door can be adjusted from 80° to 130°. Power consumption 1 x 60 mA.

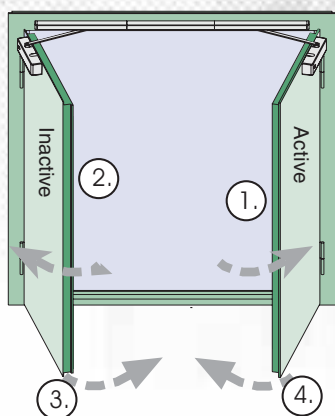

**ABLOY® FD451 Mechanical co-ordinator**

During the day the doors are normally closed and the active door is used as passage door. If both doors need to stay open, the active door must be opened first (1), after which the inactive door can be opened (2). The co-ordinator holds the active door in the desired angle during the time the inactive door is open. The inactive door stays open only if someone holds it or a wall magnet is used. When the inactive door is closed (3), the active door starts to close (4).

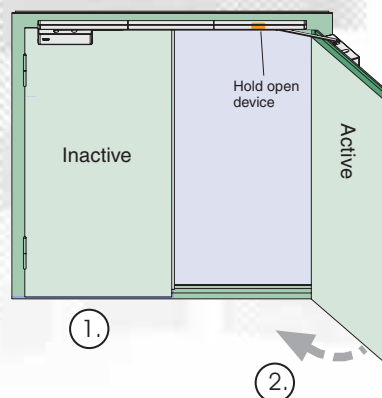
**ABLOY® FD454 Hold open for active door**

The inactive door is normally closed (1) and remains open only if someone holds it open. When the power is switched off, e.g. when smoke detectors react to smoke, the active door closes. Hold open angle for active door can be adjusted from 80° to 130°. Power consumption 1 x 60 mA.

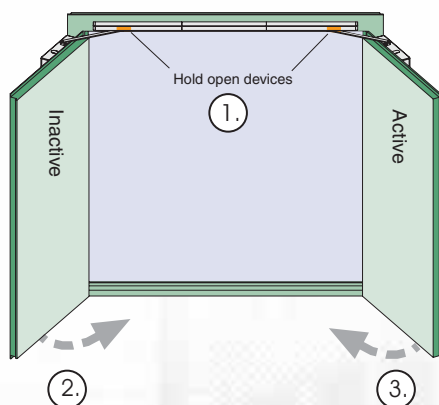
**ABLOY® FD452 Two electro-mechanical hold open devices**

The doors are held open by the hold-open devices in the selected angle (1). When the power is switched off, e.g. when the smoke detectors react to smoke, the doors close so that the inactive door closes first (2), and when it is completely closed the active door starts to close (3). Hold open angle for both doors can be adjusted from 80° to 130°. Power consumption 2 x 60 mA.

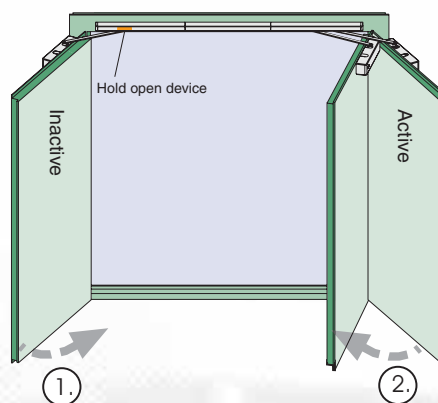
**ABLOY® FD454 Hold open for both doors**

During the day both doors are normally held open. The inactive door is held open by the hold open device in the angle determined during the installation. The active door is held open by the co-ordinator. The hold open angle of the active door is adjustable (up to 150°). When the power is switched off, e.g. when the smoke detectors react to smoke, the passive door closes first (1), and when it is completely closed, the active door starts to close (2). Power consumption 1 x 60 mA.

The above solutions can be installed on the closing side of the door with the help of a small accessory set **ABLOY® FD100** (see page 15).

OPENING SIDE INSTALLATION ON DOOR

ABLOY® FD440

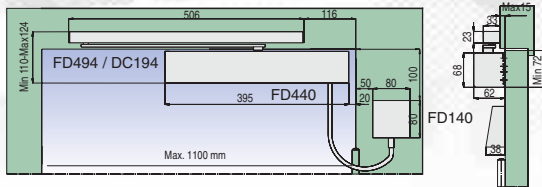

FD440 + FD494 / DC194 + FD140

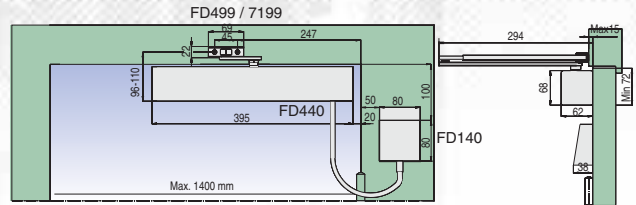

FD440 + FD499 / 7199 + FD140

OPENING SIDE INSTALLATION ON FRAME

Opening side installation on frame

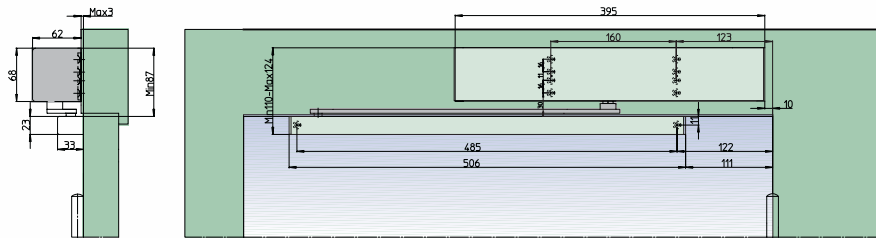

FD440 + FD494 / DC194

CLOSING SIDE INSTALLATION ON FRAME

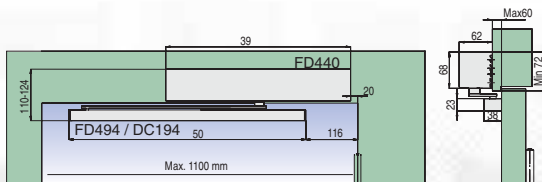

FD440 + FD494 / DC194

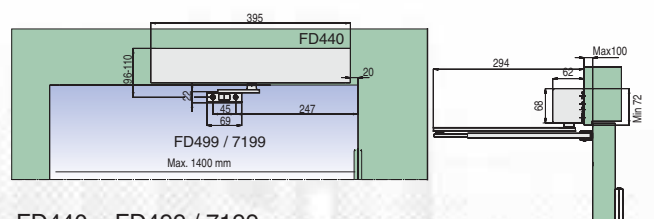

FD440 + FD499 / 7199



Opening side

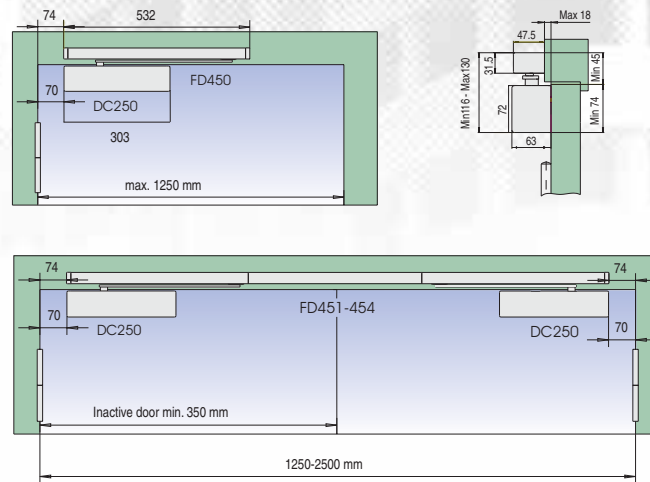

Closing side

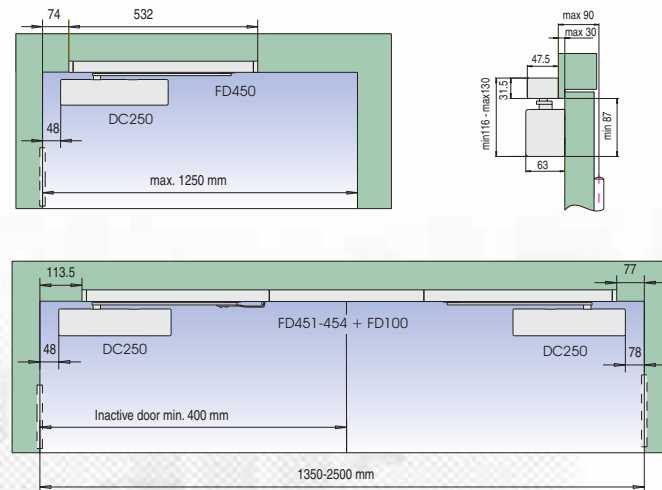

DC103 opening side

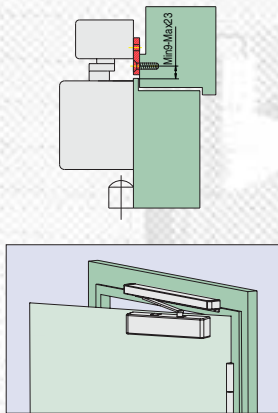

DC103 closing side

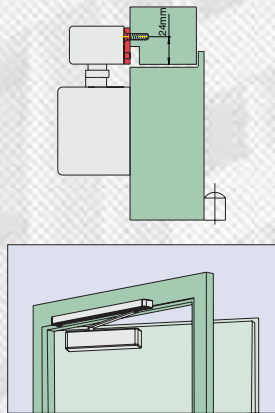

DC105 (+DC109) closing side

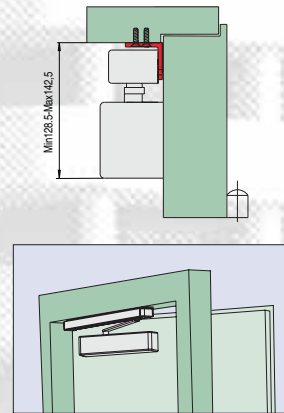

ACCESSORIES

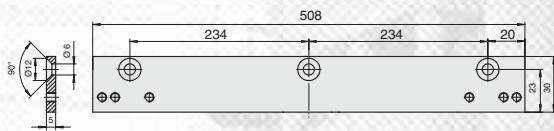

Straight mounting plate **ABLOY®** DC103 for single or double doors

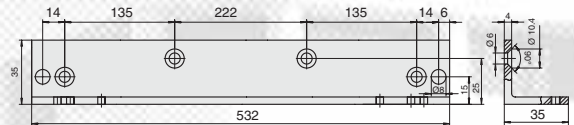

Angle mounting plate **ABLOY®** DC105 for single or double doors

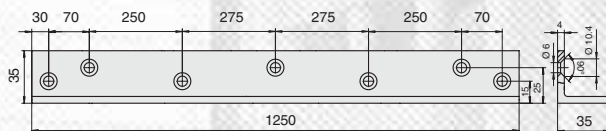

Angle mounting plate **ABLOY®** DC109 for double doors

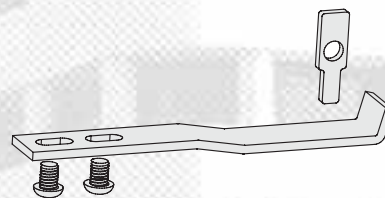

Accessory set **ABLOY®** FD100 for closing side installation in double doors



## CLASSIFICATION OF ABLOY® DOOR CLOSERS ACCORDING TO EUROPEAN STANDARD EN1154

CLASS	DC210	DC233	DC234	DC235	DC240	DC241	DC247	DC250	DC270
EN1						○		○	
EN2	○				○	○		○	
EN3	○	○		○	○	○		○	
EN4			○	○	○	○		○	
EN5				○	○	○		○	
EN6					○		○		○
EN7							○		○

### ACCESSORIES

	DC210	DC233	DC234	DC235	DC240	DC241	DC247	DC250	DC270
BC			●	●	●		●	●	●
DC				●	●				

● Accessory      ● Standard

ARMS	DC210	DC233	DC234	DC235	DC240	DC241	DC247	DC250	DC270
7190		●	●	●	●	●			
7191		●	●	●	●	●			
7199		●	●	●	●	●			
DC193		●	●	●	●	●		●	●
DC194		●	●	●	●	●		●	●
DC197							●		

### CLOSING TORQUE REQUIREMENTS (EN1154 STANDARD)

Door Closer Size	Closing torque Nm (0-4°) min.	Recommended max. door leaf width mm	Door leaf mass Kg
EN1	9	750	20
EN2	13	850	40
EN3	18	950	60
EN4	26	1100	80
EN5	37	1250	100
EN6	54	1400	120
EN7	87	1600	160

### CLOSING TORQUE REQUIREMENTS (ANSI 156.4)

Door Closer Size	Closing Torque Nm ~ 2° min.
2	10
3	17
4	27
5	37
6	47

THE **ABLOY®** DOOR CLOSER RANGE OFFERS MODELS SUITABLE FOR A WIDE VARIETY OF DOOR ENVIRONMENTS

ABLOY® DOOR CLOSER	CLASS	APPLICATION
ABLOY® DC210	2 or 3	Light interior doors, max. 60 kg and 950 mm.
ABLOY® MODUL DC233	3	Light interior doors, max. 60 kg and 950 mm.
ABLOY® MODUL DC234	4	Interior and exterior doors, max. 80 kg and 1100 mm.
ABLOY® MODUL DC234 (BC)	4	Exterior doors 80 kg and 1100 mm.
ABLOY® MODUL DC235	3 - 5	Interior and exterior doors, max. 100 kg and 1250 mm, adjustable closing force.
ABLOY® MODUL DC235 (BC)	3 - 5	Heavy exterior doors, max. 100 kg and 1250 mm.
ABLOY® MODUL DC235 (DC)	3 - 5	Any door where delayed closing feature is required. Closing force can be adjusted, max. 100 kg and 1250 mm.
ABLOY® DC240 (BC or BC and DC)	2 - 6	Exterior doors, large doors and interior doors exposed to conditions of pressure and heavy use. Adjustable closing force. Door of max. 120 kg and 1400 mm. With sliding arm max. 80 kg and 1100 mm.
ABLOY® DC241	1 - 5	Interior doors of average size and weight, max. 100 kg and 1250 mm.
ABLOY® DC247 (BC)	6 - 7	Heavy exterior and interior doors, max. 160 kg and 1600 mm, adjustable closing force.
ABLOY® DC250 (BC)	1 - 5	Interior and exterior doors, especially in FD450 fire door closing systems. Adjustable closing force. Max. 100 kg and 1250 mm.
ABLOY® DC270 (BC)	6 - 7	Interior and exterior doors especially for ships and extremely heavy doors with sliding arms DC193 and DC194. Max 160 kg and 1600 mm.
ABLOY® DC752 and DC755	3 - 6	Heavy duty floor spring with adjustable power for doors up to 300 kg and from 850 to 1400 mm wide.
ABLOY® DC802	2	Concealed door closer for aluminium profiles up to 850 mm wide.
ABLOY® DC804	4	Concealed door closer for aluminium profiles up to 1100 mm.
ABLOY® DC812	2	Concealed door closer for timber doors up to 850 mm wide.
ABLOY® DC814	4	Concealed door closer for timber doors up to 1100 mm wide.



INSTALLATION

Opening side

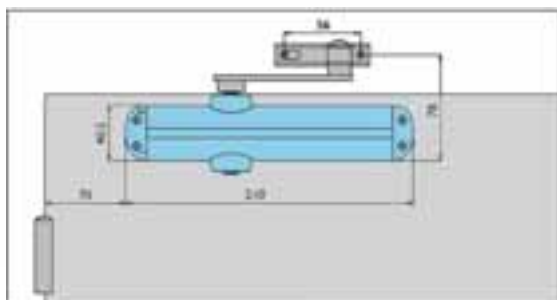

Closing side

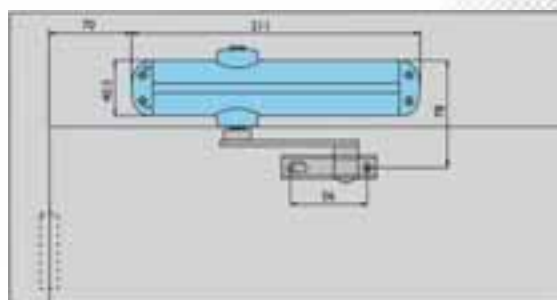

DIMENSIONS

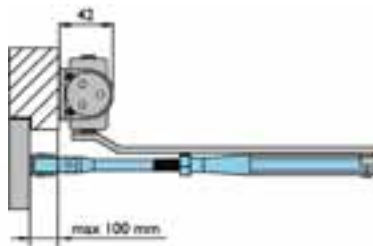
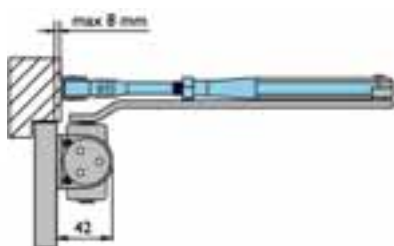

PACKAGE

Complete door closer with standard arm,  
drilling template and screws.  
ABLOY® DC210 is only available in silver.



## ADJUSTMENT

Back check (BC) and delayed closing (DC) as an adjustable optional features

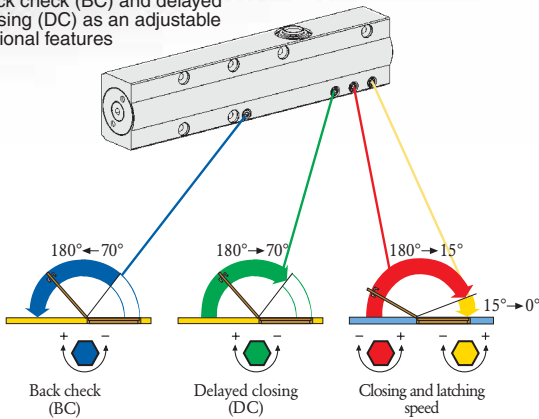

## DIMENSIONS



## ADJUSTING THE SPRING FORCE PRESET AND ARM HEIGHT

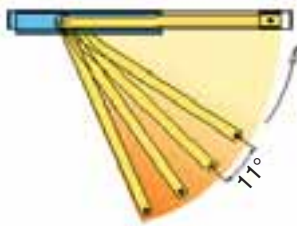

The starting angle for back check, delayed closing and latching speed can be adjusted by selecting the desired arm position in relation to the grooved spindle. Each groove represents an angle of 11 degrees.

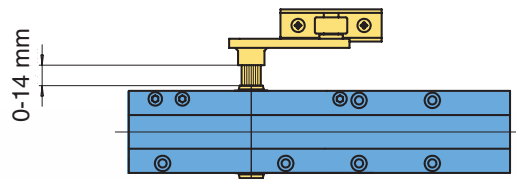

The arm height can be adjusted (max.14 mm) by moving the grooved spindle in a vertical direction.



### Ordering details

When ordering, please specify

- door closer model and colour e.g.DC235 brass
- quantity
- arm type and colour, e.g. 7190 white
- mounting plate type and colour, e.g. 7101 silver
- Note: arm and mounting plate must be ordered separately



# INSTALLATION WITH ARMS 7190, 7191 AND 7199

## Opening side

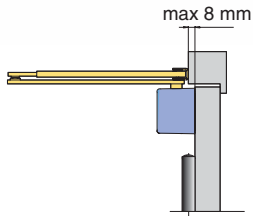
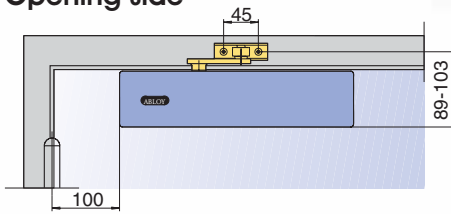

Maximum frame depth

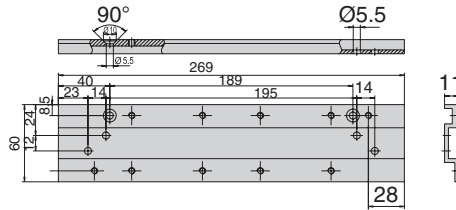

Mounting plate 7102 for profile door

## Mounting examples



Mounting without mounting plate



Mounting with mounting plate 7102 for profile door

## Closing side

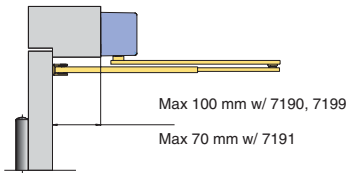
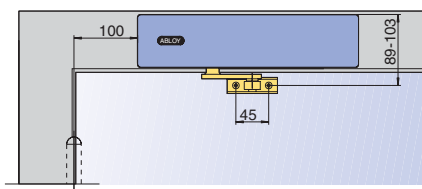

Maximum frame depth

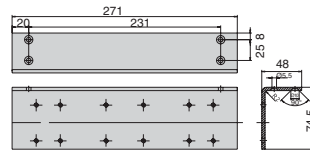

Angle mounting plate 7103

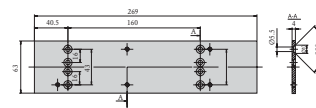

Straight mounting plate 7101

## Mounting examples



Mounting with angle mounting plate 7103



Mounting with straight mounting plate 7101

# INSTALLATION WITH PARALLEL ARM

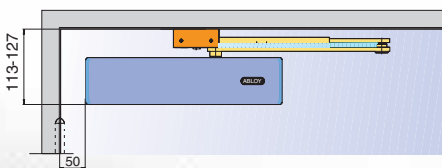

## Parallel arm bracket

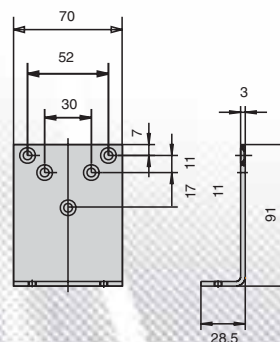

### Codes for ordering:

- 410178 aluminium
- 410179 brass
- 410180 brown
- 410181 white
- 410218 black
- 410182 special colour



**Opening side**

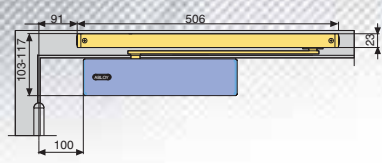

Mounting on door

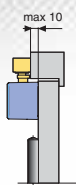

**Closing side**

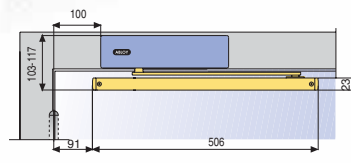

Mounting on door

Note: A door stopper needed always when installing on the closing side.

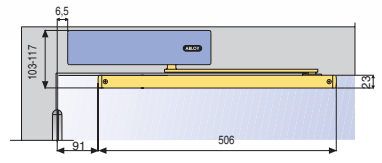
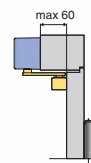

Mounting on door frame

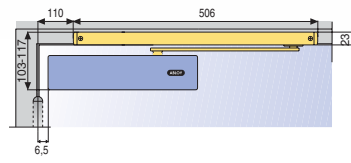
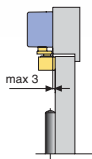

Mounting on door frame

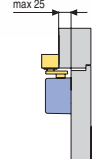

**Mounting examples**

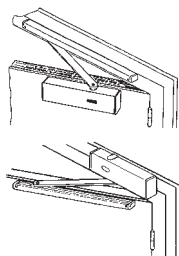

**Mounting examples**

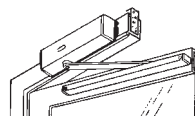

**Straight mounting plate ABLOY® DC103**

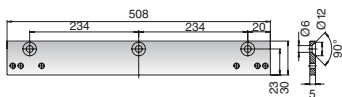

**Angle mounting plate ABLOY® DC104**

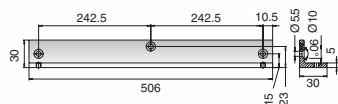

**Hold-open device ABLOY® DC152**

- Adjustable hold-open force
- Max. hold-open angle ~ 120°



**Opening damper ABLOY® DC153**

- Max. damping angle ~ 110°
- Does not replace the mechanical door stopper.
- Designed to brake the door before hitting the door stopper.





DIMENSIONS

Plastic covers



Metal covers

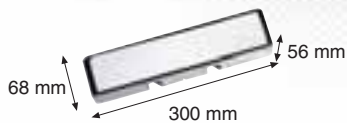

ADJUSTMENT

Back check (BC) and delayed closing (DC) as an adjustable optional features

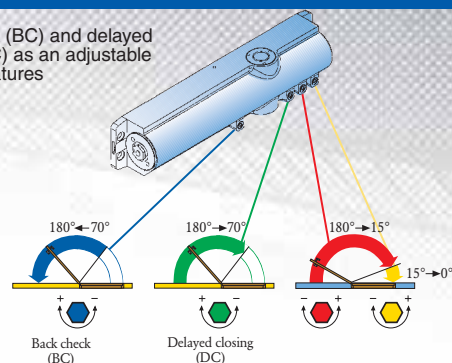

ADJUSTING THE SPRING FORCE PRESET AND ARM HEIGHT

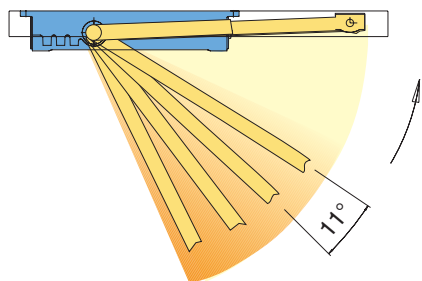

The starting angle for back check, delayed closing and latching speed can be adjusted by selecting the desired arm position in relation to the grooved spindle. Each groove represents an angle of 11 degrees.

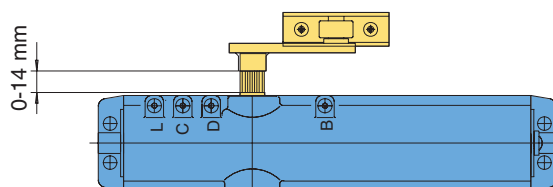

The arm height can be adjusted (max.14 mm) by moving the grooved spindle in a vertical direction.



Ordering details

- When ordering, please specify
- door closer model and colour e.g.DC240 white
  - model number and colour for the arm and support bracket (Note: must be ordered separately)
  - quantity
  - delayed closing (DC) operation, if required (in DC240)

Opening side

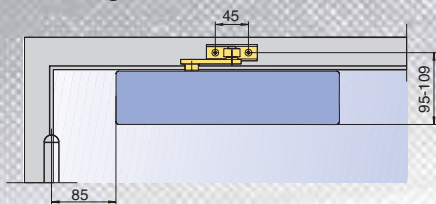

Maximum frame depths

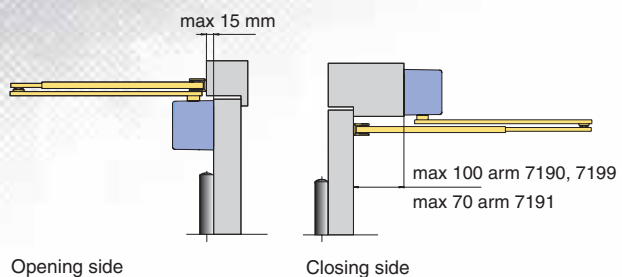

Closing side

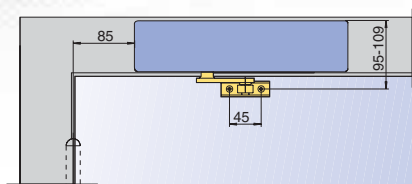

Support brackets

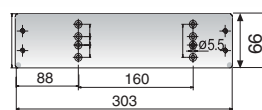

DC106

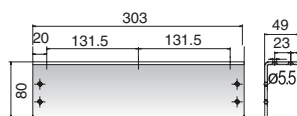

DC107

Mounting examples

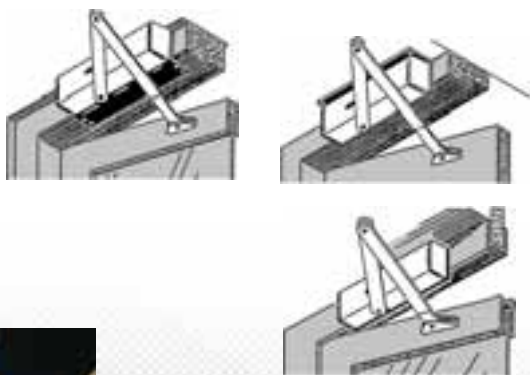



Opening side

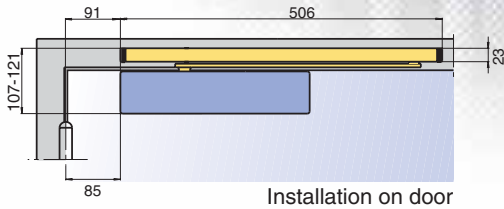

Installation on door

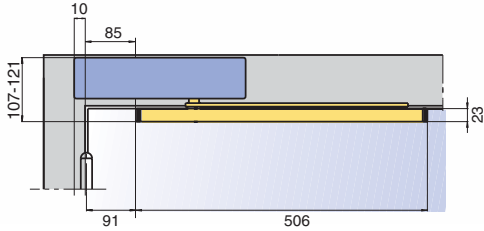

Installation on door frame

Closing side

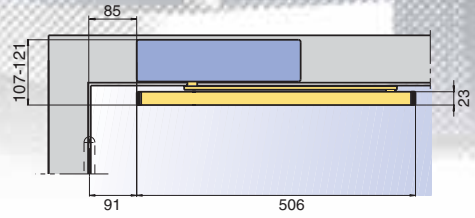

- Max. opening angle ~ 130°
- Note: a door stopper needed always when installing on the closing side

Opening side

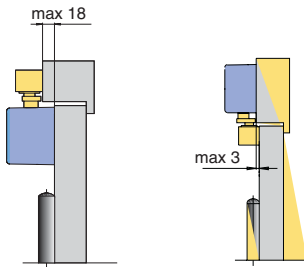

Closing side

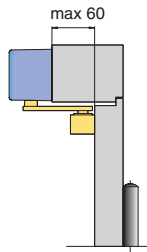

Installation with parallel arm  
(Only for installation on the closing side)

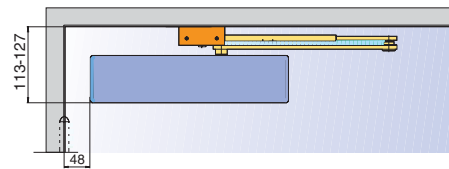

Mounting examples

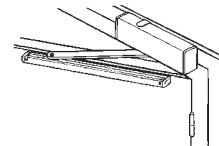
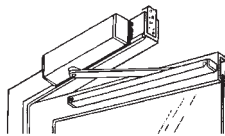
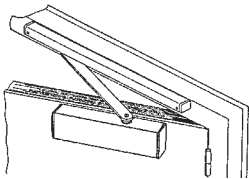

ACCESSORIES FOR SLIDING ARMS DC193 AND DC194



- Hold-open device ABLOY® DC152**
- Adjustable hold-open force
  - Max. hold-open angle ~ 120°



- Opening damper ABLOY® DC153**
- Max. damping angle ~ 110°
  - Does not replace the mechanical door stopper.
  - Designed to brake the door before hitting the door stopper.

**Straight mounting plate ABLOY® DC103**

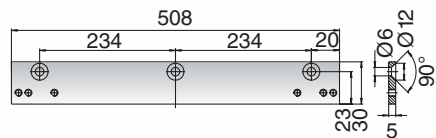

**Angle mounting plate ABLOY® DC104**

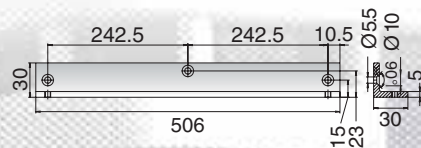

## ADJUSTMENT

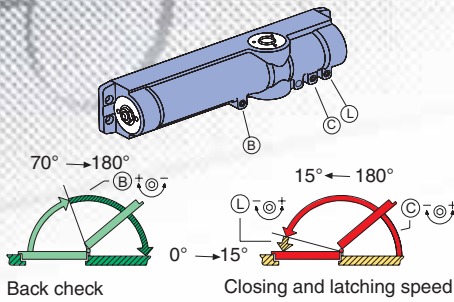

## DIMENSIONS

### Plastic covers

### Metal covers

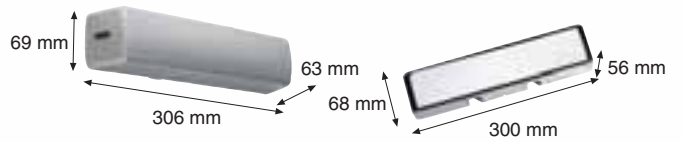

## ADJUSTING THE SPRING FORCE PRESET AND ARM HEIGHT

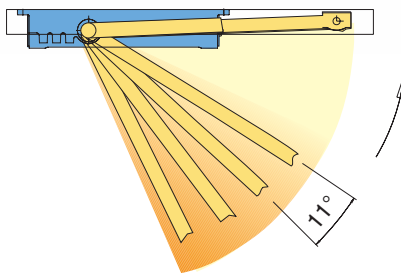

The starting angle for back check, delayed closing and latching speed can be adjusted by selecting the desired arm position in relation to the grooved spindle. Each groove represents an angle of 11 degrees.

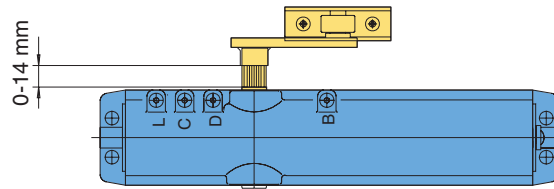

The arm height can be adjusted (max.14 mm) by moving the grooved spindle in a vertical direction.

## INSTALLATION WITH STANDARD ARM DC197

### Opening side

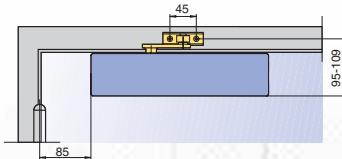

### Closing side

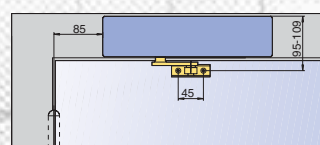

### Maximum frame depth

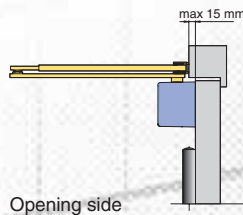

Opening side

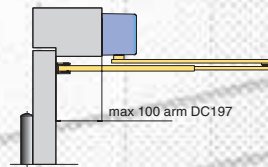

Closing side

### Support brackets

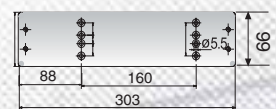

DC106

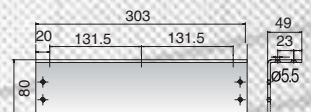

DC107





**DIMENSIONS**

**Plastic covers**

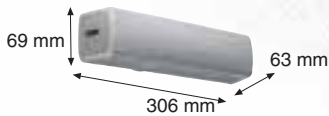

**Metal covers**

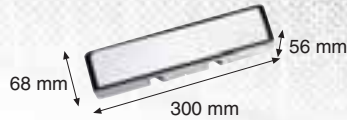

**Arm DC194**

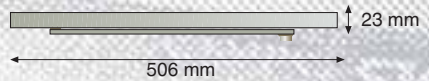

**ADJUSTING THE SPRING FORCE PRESET AND ARM HEIGHT**

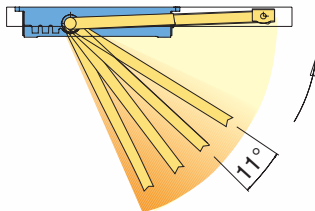

The starting angle for back check, delayed closing and latching speed can be adjusted by selecting the desired arm position in relation to the grooved spindle. Each groove represents an angle of 11 degrees.

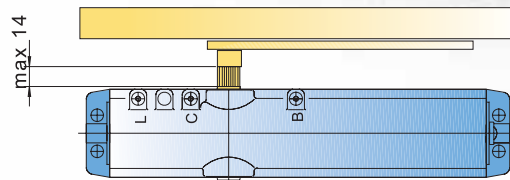

The arm height can be adjusted (max. 14 mm) by moving the grooved spindle in a vertical direction.

**INSTALLATION**

**Opening side**

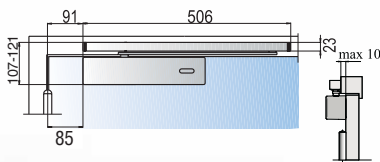

Installation on door

Max. frame depth

**Closing side**

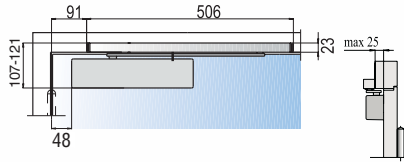

Installation on door

Max. frame depth

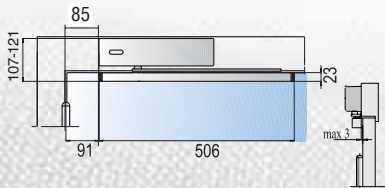

Installation on door frame

Max. frame depth

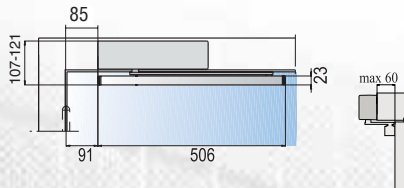

Installation on door frame

Max. frame depth

**ADJUSTMENT**

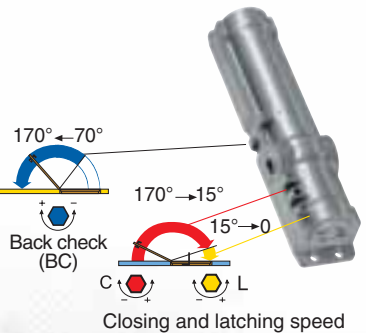

**ACCESSORIES FOR SLIDING ARMS DC193 AND DC194**



**Hold-open device ABLOY® DC152**

- Adjustable hold-open force
- Max. hold-open angle ~ 120°



**Opening damper ABLOY® DC153**

- Max. damping angle ~ 110°
- Does not replace the mechanical door stopper.
- Designed to brake the door before hitting the door stopper.



**Straight mounting plate ABLOY® DC103**

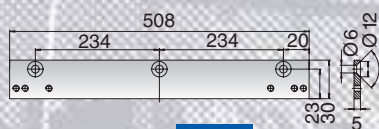

**Angle mounting plate ABLOY® DC104**

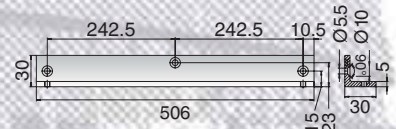

# ABLOY® DC270

## ABLOY® DC270 DOOR CLOSER WITH SLIDING ARM

### DIMENSIONS

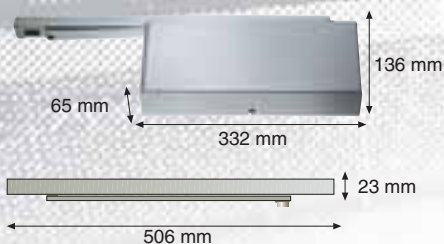

### ADJUSTMENT

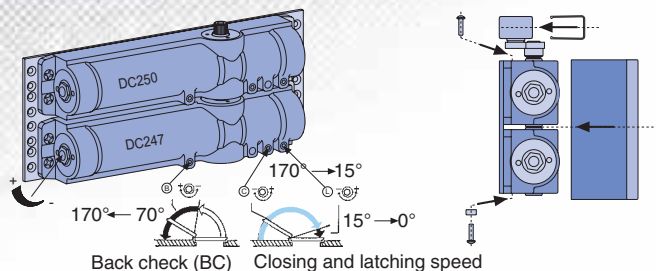

### ADJUSTING THE SPRING FORCE PRESET AND ARM HEIGHT

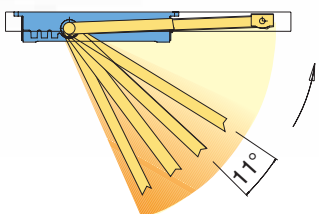

The starting angle for back check, delayed closing and latching speed can be adjusted by selecting the desired arm position in relation to the grooved spindle. Each groove represents an angle of 11 degrees.

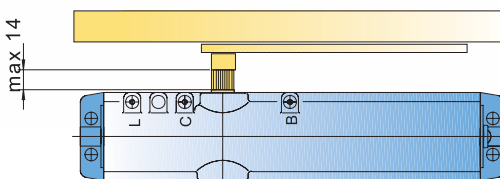

The arm height can be adjusted (max. 14 mm) by moving the grooved spindle in a vertical direction.

### INSTALLATION

#### Support brackets

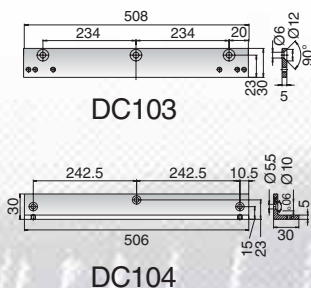

#### Opening side

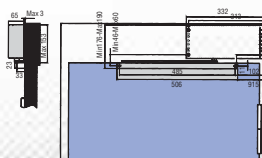

Installation on frame

#### Opening side

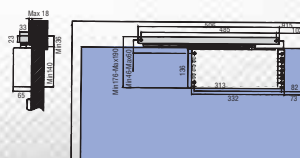

Installation on door

#### Closing side

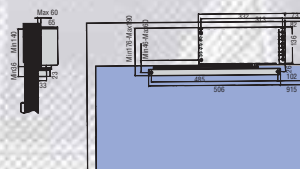

Installation on frame

### ACCESSORIES FOR SLIDING ARMS DC193 AND DC194



#### Opening damper ABLOY® DC153

- Max. damping angle ~ 110°
- Does not replace the mechanical door stopper.
- Designed to brake the door before hitting the door stopper.



**DIMENSIONS**

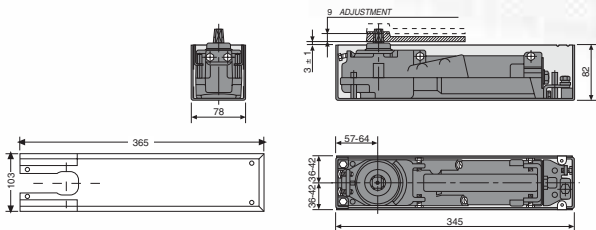

**ADJUSTMENT**

CLOSING POWER AND CLOSING SPEED ADJUSTMENT

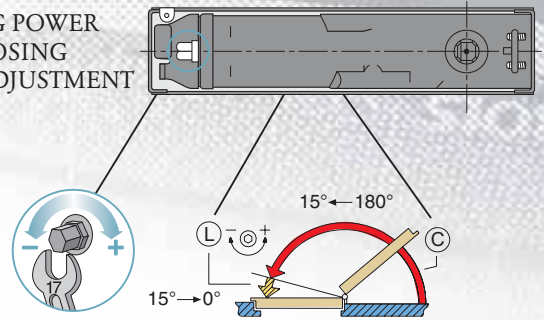

Turn clockwise force adjustment  $\varnothing 17$  mm to increase power. Turn anti-clockwise to decrease power. Starting from the minimum power, with 10 complete turns maximum power is reached.

Valve C control closing speed from 180° to 15° and valve L control final closing speed from 15° to 0°. Starting from valve closed, with three full turns anti-clockwise, maximum speed is reached.

**INSTALLATION**

RIGHT

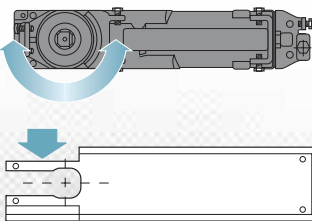

DOUBLE ACTING

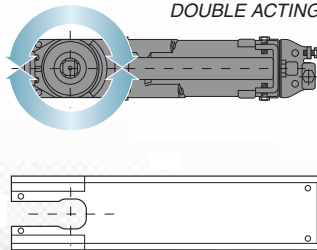

LEFT

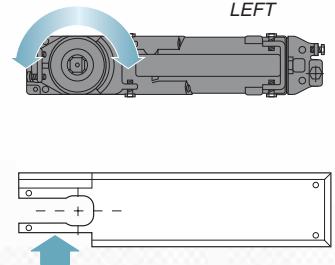

ABLOY® DC752 and DC755 are suitable for right, left or double acting doors by just changing the accessories.

**ACCESSORIES**

**ABLOY® DC701**

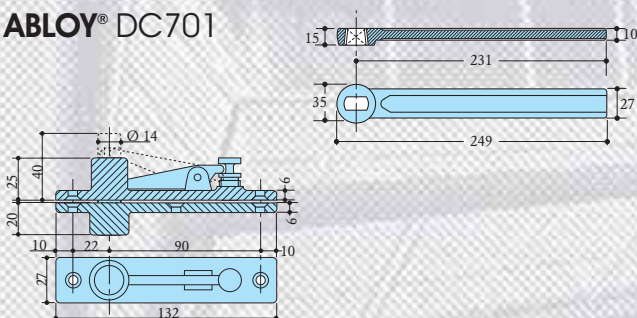

DC701 is an accessory hinge packet to the floor springs. It is straight model and suitable to the double action door. Rectangular German spindle.

**ABLOY® DC702**

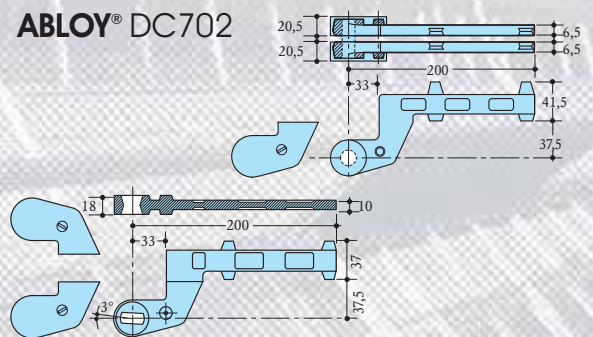

DC702 is an accessory hinge packet to the floor springs. It is 36 mm offset model to the right or left hand single acting door. Rectangular German spindle.

**DIMENSIONS**

**Installation on door**

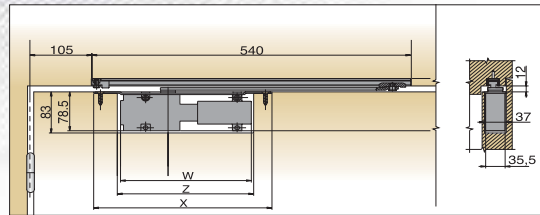

	<b>X</b>	<b>Z</b>	<b>W</b>
DC802/DC812	298	226	221
DC804/DC814	404	332	327

**Installation on door frame**

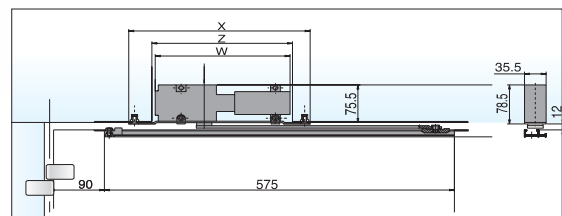

**INSTALLATION**



**ACCESSORIES**

**ABLOY® DC852 HOLD OPEN DEVICE**

Hold open angle from 80° to 110°

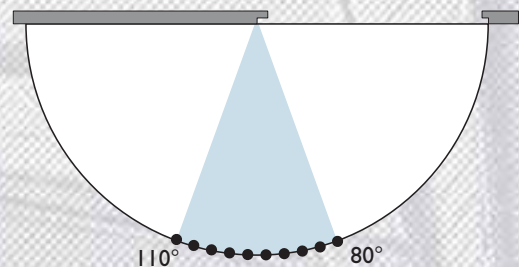
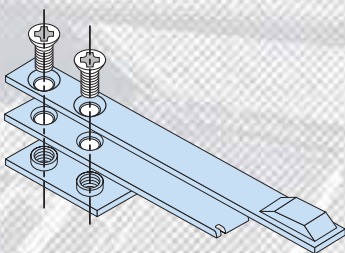



## COLOURS FOR DOOR CLOSERS

### Plastic covers

Black  
Brown  
White  
Brass  
Silver



**ABLOY®** MODUL DC230 SERIES DOOR CLOSERS  
**ABLOY®** DC240/DC241 DOOR CLOSER  
**ABLOY®** DC247 DOOR CLOSER  
**ABLOY®** DC250 DOOR CLOSER

Note:

**ABLOY®** DC210 is available only in silver.  
 No cover available.

### Metal covers

Stainless steel  
 Bright brass  
 Bright chrome



The following door closers are available also with metal cover  
**ABLOY®** DC240/DC241 DOOR CLOSER  
**ABLOY®** DC247 DOOR CLOSER  
**ABLOY®** DC250 DOOR CLOSER

Note:

**ABLOY®** DC270 is available only with metal cover.  
 Colours black, brown, white, brass and silver.

## ARMS

**ABLOY®** DC210  
 Incl. own arm.

**ABLOY®** MODUL DC230 SERIES DOOR CLOSERS  
 Standard arm 7190  
 Hold-open arm 7191  
 Special arm 7199  
 Sliding arm DC193 and DC194

**ABLOY®** DC240/DC241 DOOR CLOSERS  
 Standard arm 7190  
 Hold-open arm 7191  
 Special arm 7199  
 Sliding arm DC193 and DC194

**ABLOY®** DC247 DOOR CLOSER  
 Special arm DC197

**ABLOY®** DC250 DOOR CLOSER  
 Sliding arm DC193/DC194

**ABLOY®** DC270 DOOR CLOSER  
 Sliding arm DC193/DC194



**7190 Standard arm**



**7199 Special arm  
 DC197 Special arm**



**7191 Hold-open arm**



**Sliding arm DC194**



**Sliding arm DC193**



**Parallel arm  
 bracket for  
 7190, 7191, 7199 and DC197**

## OPERATION OF DOOR CLOSERS

Operation is based on a hydraulically controlled rack and pinion mechanism. Within the closer there is oil to control the closing and latching speeds and delayed closing and back check features. The adjustable valves enable the adjustment of the speeds and features.

Opening a door, the spring inside the closer is becoming tense. When the door is released the potential of the spring push the piston back and door closes. Pressure relief valves are a standard feature (excluding DC210) to protect the door from abuse and ensure reliable operation in demanding conditions.

### Closing speed, C-valve

Closing speed (Valve C) can be adjusted from door opening angle 180 degrees to 15 degrees. Valve C provides a wide range on closing speed.

### Latching speed, L-valve

The latching speed (Valve L) can be adjusted from 15 to 0 degree. In case door is sealed more speed is required to ensure that door latches.

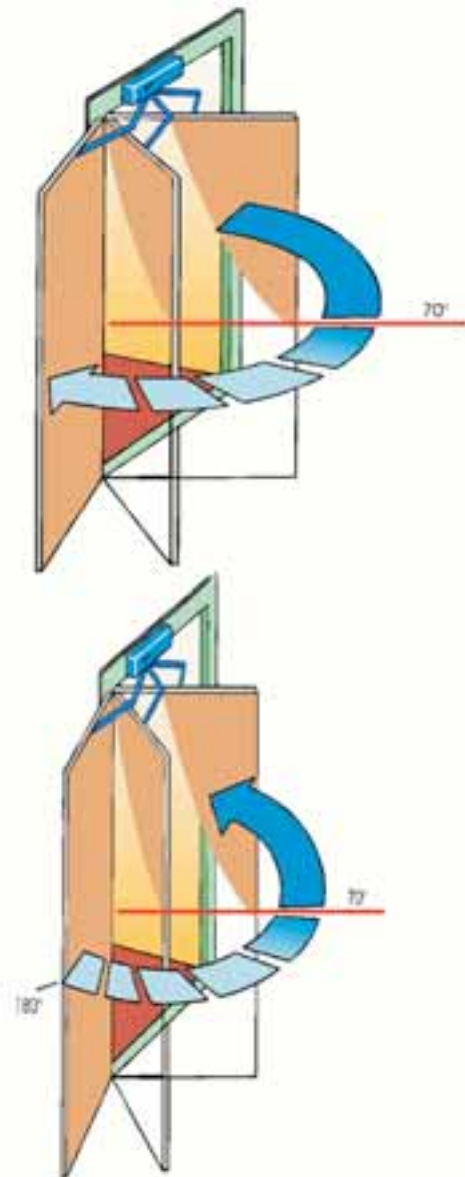

## BACK CHECK (BC)

A brake affects door movement from 70°-80° to fully open (180°) and protects the door by preventing it from being pulled open by the wind. This feature can be adjusted by selecting the desired arm position. Adjustment by using valve-B. Recommended for use with external doors.

## DELAYED CLOSING (DC)

Delayed closing slows down the movement of the door from fully open (180°) to approximately 70°, after passing this point the door closes at normal speed. The starting angle can be adjusted by selecting desired arm position. Closing speed can be adjusted by adjustable valve D. Adjustable valve enables the adjustment of closing speed. Recommended for internal doors.

## ADJUSTABLE CLOSING FORCE

**ABLOY®** DC235, DC240/DC241, DC247, DC250 and DC270 door closers are equipped with adjustable spring power which ensures the pre-setting of spring.

Due to adjustable spring power, the same door closer can be used in various applications.



## ABLOY® – the sign for security



The quality and environmental systems used by Abloy Oy guarantee that customers can be certain of **ABLOY®** quality in every field. We received our first Quality System Certificate - SFS-EN ISO 9001 - in 1989. Just eight years later, Abloy Oy was one of the first companies in Finland to be granted an SFS-EN-ISO 14001 Environmental System Certificate.

Our products are designed and manufactured not only to provide high levels of security, but also to be reliable, user-friendly and aesthetically pleasing. **ABLOY®** is your sign for security.



**ABLOY®** is a registered trademark of Abloy Oy, one of the leading manufacturers of locks, locking systems and architectural hardware and the world's leading developer of products in the field of electromechanical lock technology.

The unique **ABLOY®** detainer disc cylinder mechanism has several advantages over conventional locking mechanisms. Ever since its invention in 1907, it has been a symbol of high security and superior performance.

Our range consists of electromechanical locks, cam locks, padlocks, office furniture locks, rim locks, lock cases, cylinders for different types of mortice locks, door closers, door automatics and architectural hardware. **ABLOY®** locking solutions for every application are available from our world-wide network of distributors.

Customer-oriented development, combined with our long experience and extensive security expertise, mean that **ABLOY®** security solutions employ the very latest technology to meet your needs.



[www.abloy.com](http://www.abloy.com)

Abloy Oy  
Wahlforssinkatu 20  
P.O. Box 108  
FI-80101 JOENSUU  
FINLAND  
Tel. +358 20 599 2501  
Fax +358 20 599 2209

